

KATT

SAFETY

A MODULAR SAFETY SYSTEMS BRAND



Protecting life by providing permanent
Safe Access Systems

PRODUCTS

KATT SAFETY offer a wide range of innovative, modular, market leading protection & access systems

KATT
CLIMB

KATT
GUARD

KATT
WALK

KOMBI
MODULAR

WELCOME TO **KATT SAFETY**

Protecting life by providing permanent
Safe Access Systems

KATT Safety is a trusted provider of high-quality fall protection and access systems that protect life and enable safe work at height.

Our fixed ladders, guardrails and walkways are precision-engineered modular systems, so can be configured to meet the height safety needs of any commercial or industrial environment, this unique design coupled with quality materials and many years of hands-on experience from our team has made us a favourite of many long standing clients.

We are passionate about delivering a blend of products and service that goes beyond achieving compliance. We are focused on helping our customers effectively manage work at height risks in a way that protects their company and, most importantly, the people that work in, on and around their buildings.

OUR SERVICES INCLUDE

- Fast Nationwide Delivery
- Supplied in kit form
- Site Surveys
- Powder Coating Services on many products

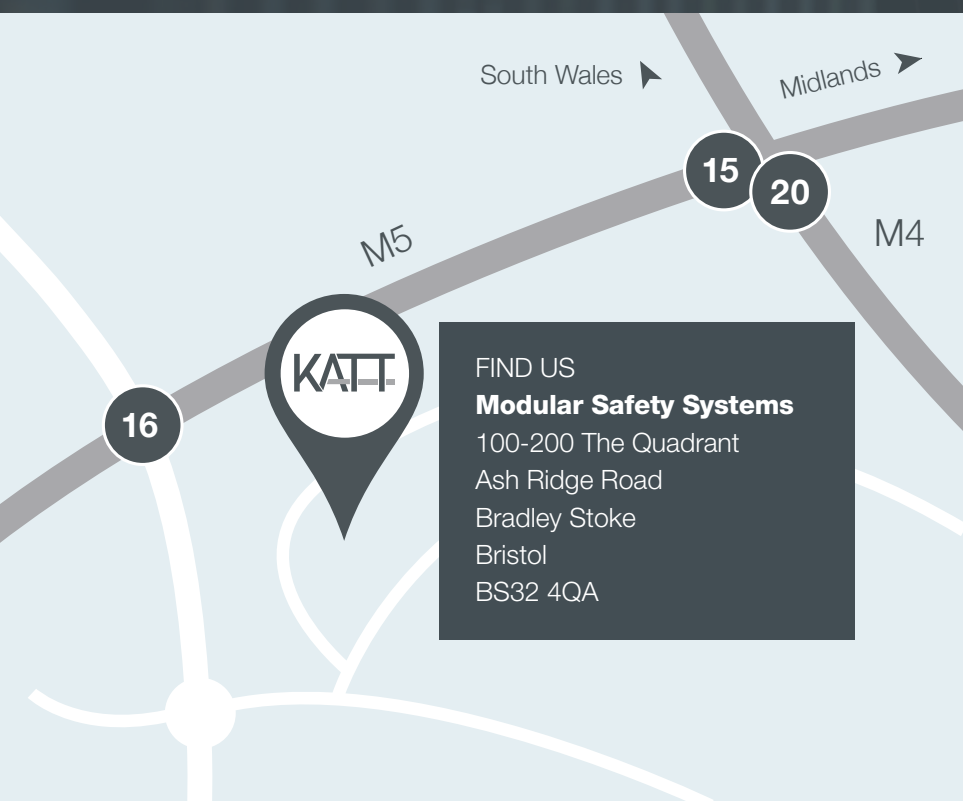

CALL US
0800 0590 400



EMAIL US
katt@modsafe.co.uk



VISIT US ONLINE
kattsafety.co.uk



CONTENTS

2	Welcome to KATT SAFETY
4	Our Brands
5	Our Promise
6	About KATT CLIMB
8	KATT CLIMB Products
18	KATT CLIMB Accessories
20	KATT CLIMB Summary of Standards
21	KATT CLIMB Technical Specifications
22	About KATT GUARD
24	KATT GUARD Products
28	KATT GUARD Accessories
29	KATT GUARD Technical Specifications
30	About KATT WALK
32	KATT WALK Products
34	KATT WALK Accessories
35	KATT WALK Technical Specifications
34	About KOMBI
36	KOMBI Products
40	KOMBI Components
42	KOMBI Assurance
43	KOMBI Technical Specifications

KATT

CLIMB

KATT

GUARD

KATT

WALK

KUMBI

MODULAR

Angled Fixed Ladders
 Vertical Fixed Ladders
 Caged Ladders
 Fall Arrest Ladders
 Fold Down Ladders
 Ladder Accessories

Modular Guardrail Systems
 Warning Line Systems
 Ladder Protector Systems
 Roof Hatch Systems
 Skylight Protection Systems

Metal Roof Walkways
 Flexible Walkway Systems

Modular Stair Bridges
 Step Bridges
 Stair Systems
 Ship Ladders
 Ramp Systems

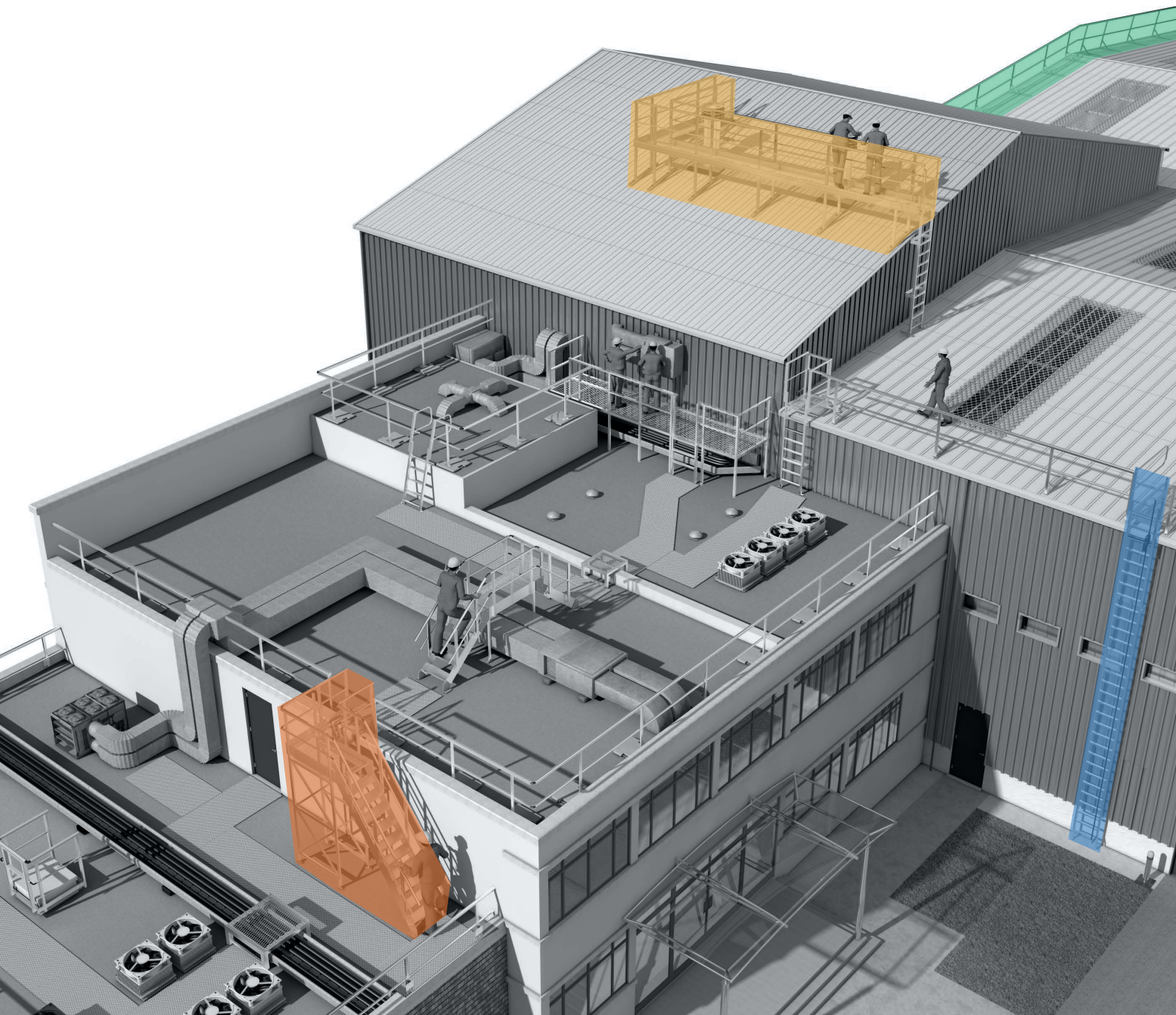

OUR PROMISE



Modular System

Components used in our modular access systems are fabricated in sections. This allows for endless construction and multiple configurations to suit specific site requirements. Components are robotically welded for a precision perfect finish.



On-Site Assembly

Each access system is provided with necessary hardware. Wall attachment hardware is also available on request. Simple adjustments can be made on site to ensure the system suits exact site requirements.

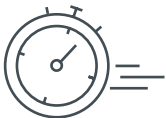

Minimum Lead Time

KATT SAFETY modular components are kept in stock, and are typically ready to be dispatched within a few days from order or as required.



Safety

Careful, precision consideration has gone into the design of our modular access systems to ensure maximum safety in all kinds of conditions.



Appearance

Our modular access systems are not only very easy to assemble, but look great also! Supplied in aluminium finish as standard, but can also be custom coloured if required.



Easy Delivery

The lightweight components are delivered as a flat-pack kit, which ensures easier handling and significant savings on freight costs. Depending on the size of the ladder and access system, the components can be possibly man handled to the required location or crane lifted once at destination.



Compliant

All systems are manufactured to ISO 9001 quality management standards and comply with the relevant British Standards BS4211:2005 + A1:2008.



KATT CLIMB

FIXED LADDERS & ACCESSORIES

COMMON APPLICATIONS FOR LADDERS

- Access from the ground to roofs and elevated areas
- Access between varying roof levels
- Access to rooftop machinery and equipment platforms such as factory chimneys, radio masts, storage tanks and more

KATT modular access ladders are an extremely versatile range of fixed access ladders.

KATT CLIMB® modular fixed ladders are the perfect solution for safe and easy access to elevated areas such as rooftops, ceiling spaces and maintenance platforms and more. The unique, precision modular design of the system, ensures a high level of safety and confidence for maintenance personnel which is quick & simple to install, and easily adjustable to suit your specific site requirements.

Ladders can be used at angles from 75° to vertical and can be supplied complete with fall arrest cages and landing platforms.

The lightweight, high-strength, aluminium design provides safe and easy installation with non-corrosive, industrial-rated system performance ensuring maximum safety on your premises for many years to come.

KATT Safety is all about **protecting life by providing permanent Safe Access Systems**, that's why we are focused on helping you effectively manage work at height risks in a way that protects your company and, most importantly, the people that work in, on and around the premises.



The KATT principle – Simple and compliant



KATT single flight ladder

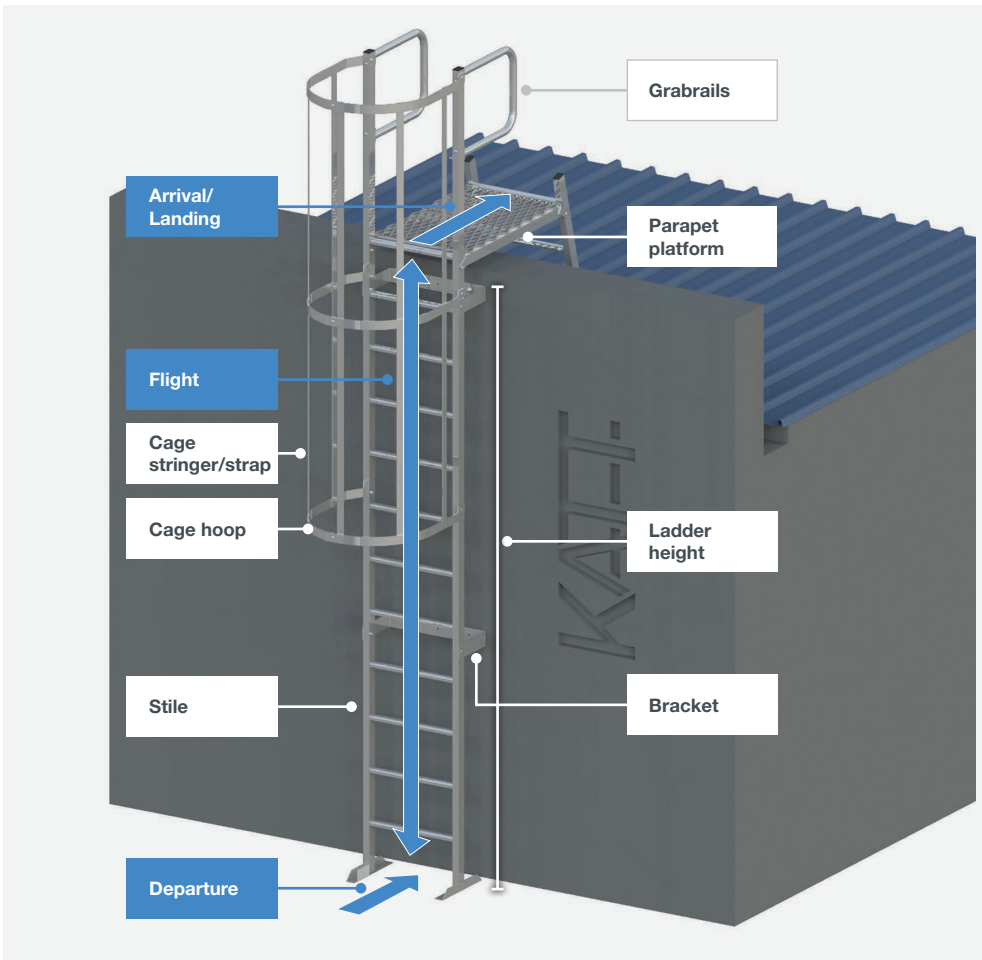

KATT RL20

Angled mini access ladders



The KATT angled mini access ladders are ideally suited to providing access between different roof levels and plant platforms where the height is 2.5m or less. The angled climb makes these ladders user-friendly and well suited to areas where regular access is required.



RL21 Angled mini access ladder with grabrails

Ideally suited to providing access between varying levels.

APPLICATIONS INCLUDE:

- Lower roofs to upper roofs
- Plant platform access
- Varying floor heights



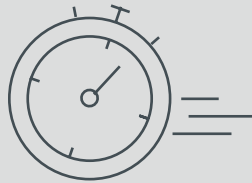

Minimum lead time

KATT SAFETY modular components are kept in stock, and are typically ready to be dispatched within a few days from order or as required.



RL22 Angled mini access ladder with parapet platform

Ideally suited to providing access between varying levels where there is a parapet wall.

APPLICATIONS INCLUDE:

- Parapet walls
- Access to canopies
- Lower roofs to upper roofs



RL23 Angled mini access ladder with walkway

Ideally suited to accessing elevated areas where extra safety levels are required. The 2.4m long walkway takes the user at least 2m away from the roof edge, where it is accepted that the worker is in a safe zone.

APPLICATIONS INCLUDE:

- Access between varying roof levels
- Access to canopies
- Access to plant platforms



RL24 Angled mini access ladder with retractable stiles

Ideally suited to providing access to elevated areas through a hatch or opening.

APPLICATIONS INCLUDE:

- Access between varying roof levels
- Access to canopies
- Access to plant and equipment

RL20 LADDER HEIGHT OPTIONS

RL21	RL22	RL23	RL24
1350mm	1350mm	1350mm	1200mm
2550mm	2550mm	2550mm	2400mm

KATT RL30

Vertical access ladders

The KATT vertical access ladders are ideally suited to providing access between different roof levels and plant platforms where the height is 2.5m or less. The vertical fixture means they take up less space than an angled ladder, which makes them more suitable for areas where a compact solution is required.

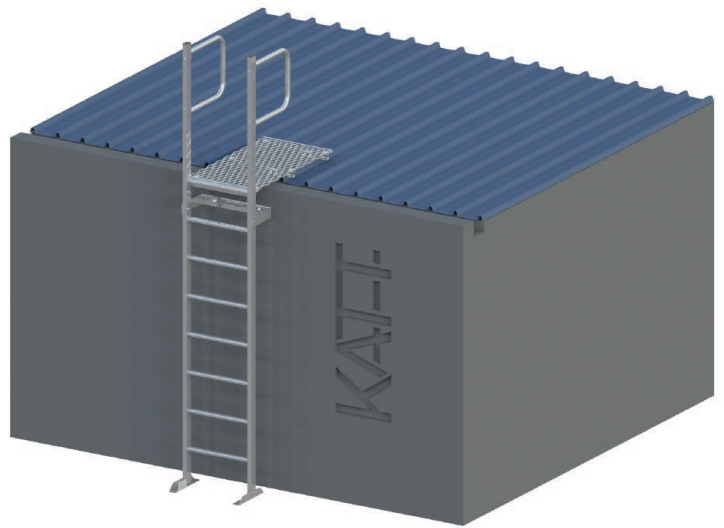

RL31 Vertical access ladder with grabrails

Ideally suited to providing access between varying levels.

APPLICATIONS INCLUDE:

- Lower roofs to upper roofs
- Plant platform access
- Varying floor heights



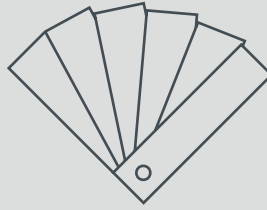

Want your ladder in another colour?

Our ladders can be powder coated in most RAL colours, such as:



RL32 Vertical access ladder with parapet platform

Ideally suited to providing access between varying levels where there is a parapet wall.

APPLICATIONS INCLUDE:

- Parapet walls
- Access to canopies
- Lower roofs to upper roofs



RL33 Vertical access ladder with walkway

Ideally suited to accessing elevated areas where extra safety levels are required. The 2.4m long walkway takes the user at least 2m away from the roof edge, where it is accepted that the worker is in a safe zone.

APPLICATIONS INCLUDE:

- Access between varying roof levels
- Access to canopies
- Access to plant platforms



RL34 Vertical access ladder with retractable stiles

Ideally suited to providing access to elevated areas through a hatch or opening.

APPLICATIONS INCLUDE:

- Access between varying roof levels
- Access to canopies
- Access to plant and equipment

RL30 LADDER HEIGHT OPTIONS

RL31	RL32	RL33	RL34
1350mm	1350mm	1350mm	1200mm
2550mm	2550mm	2550mm	2400mm

KATT RL40

Caged access ladders

The KATT caged access ladders provide basic fall protection, which is required on all ladders over 3m high, in compliance with BS4211:2005 & BS EN ISO 14122-4:2016.

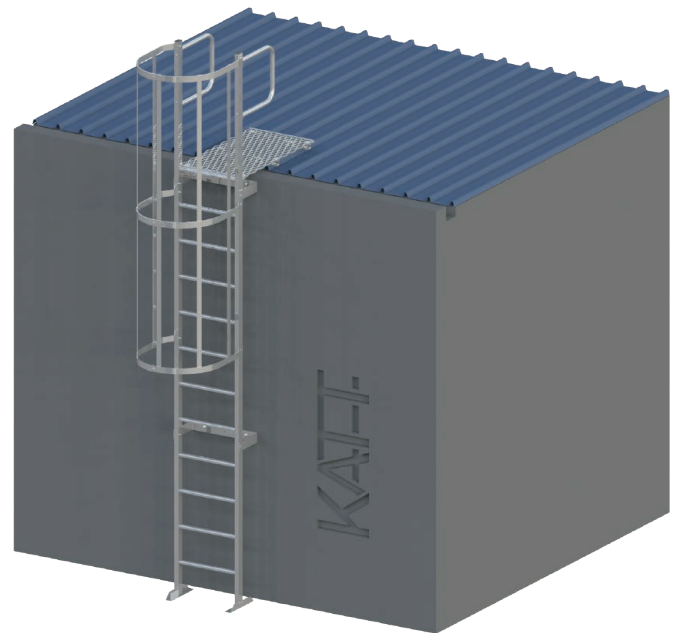

RL41 Caged access ladder with grabrails

The perfect solution for application heights over 3m, where standards require fall protection.

APPLICATIONS INCLUDE:

- Primary access from ground to roof area
- Lower roofs to upper roofs
- Plant platform access

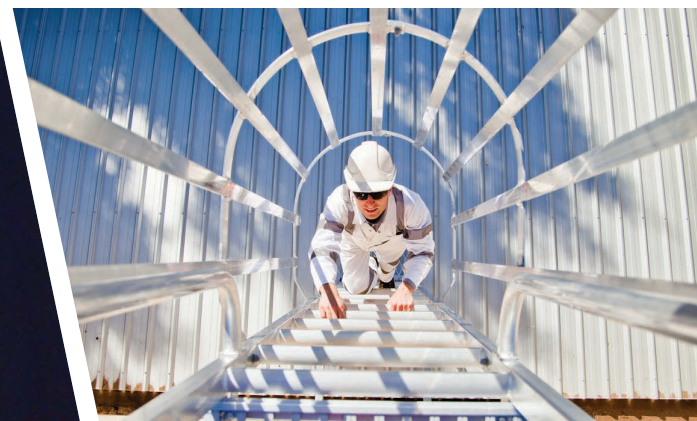



What if the height required is greater than 10m?

When the height is greater than 10m, a staggered flight ladder must be installed. The climbing height of the individual ladders must be 6m or less and an intermediate rest platform must be provided between each ladder.

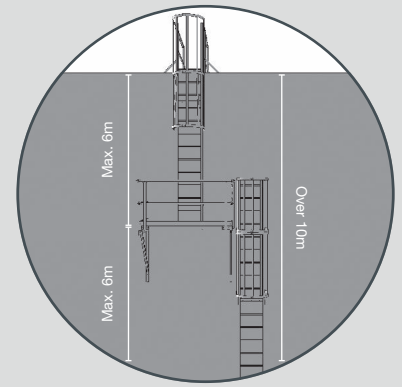

RL42 Caged access ladder with parapet platform

The perfect solution for application heights over 3m, where there is a parapet wall.

APPLICATIONS INCLUDE:

- Primary access from ground to roof area
- Lower roofs to upper roofs
- Parapet walls



RL43 Caged access ladder with walkway

Ideally suited to accessing elevated areas over 3m high, where extra safety levels are required. The 2.4m-long walkway takes the user at least 2m away from the roof edge, where it is accepted that the worker is in a safe zone.

APPLICATIONS INCLUDE:

- Primary access from ground to roof area
- Access to canopies
- Access between varying roof levels



RL44 Caged access ladder with retractable stiles

Ideally suited to providing access to elevated areas over 3m high, through a hatch or opening.

APPLICATIONS INCLUDE:

- Access between varying roof levels and mezzanines
- Access to canopies
- Access to plant and equipment

RL40 LADDER HEIGHT OPTIONS

RL41	RL42	RL43	RL44
2550mm	2550mm	2550mm	2400mm
3750mm	3750mm	3750mm	3600mm
4950mm	4950mm	4950mm	4800mm
6150mm	6150mm	6150mm	6000mm
7350mm	7350mm	7350mm	7200mm
8550mm	8550mm	8550mm	8400mm
9750mm	9750mm	9750mm	9600mm

KATT RL50

Vertical line ladders

The KATT vertical line ladders included a fall arrest system which provides constant fall protection at any point on the ladder. All ladders are manufactured from structural grade aluminium, making them strong and yet lightweight to install. Formed and designed for vertical installation meaning minimal floor space is required.

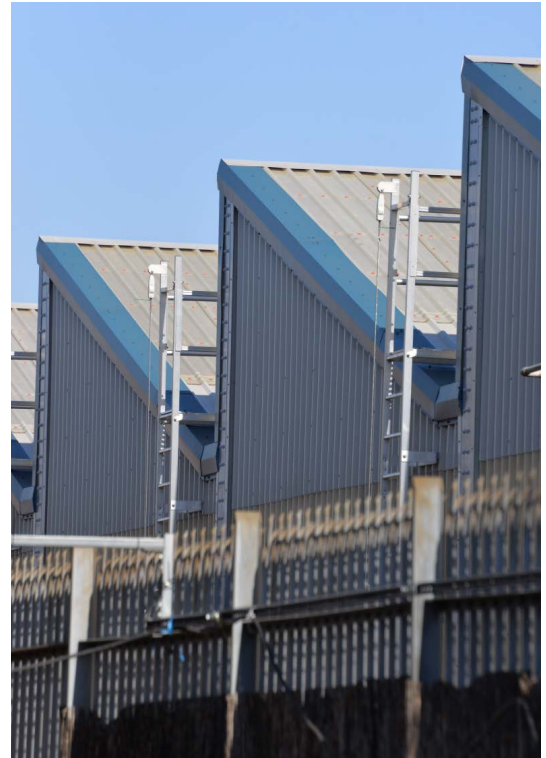

ADVANTAGES OF FALL ARREST SYSTEMS

- Constant fall protection at any point on the ladder
- Minimal Floor footprint required for ladder
- Simple to use by competent personnel





When do I need an intermediate landing?

All vertical line ladders greater than 12m high must have midway rest platform. Intermediate platforms available for all KATT Ladder series and shown on page 19.



RL52 Vertical line ladder with parapet platform

Modular vertical line fall arrest ladder with grabrails, parapet platform and 1m landing.



RL53 Vertical line ladder with 2.4m platform

Modular vertical line fall arrest ladder with 2.4m long adjustable platform.

RL50 LADDER HEIGHT OPTIONS

RL52	RL53
1350mm	1350mm
2550mm	2550mm
3750mm	3750mm
4950mm	4950mm
6150mm	6150mm
7350mm	7350mm
8550mm	8550mm
9750mm	9750mm
12150mm	12150mm

KATT RL70

Angled step ladders

The KATT step ladders provide an easy climb for accessing areas at height where space is not a limitation. All ladders are manufactured from structural grade aluminium, making them strong and yet lightweight to install. All step ladders are installed to 65° angle.

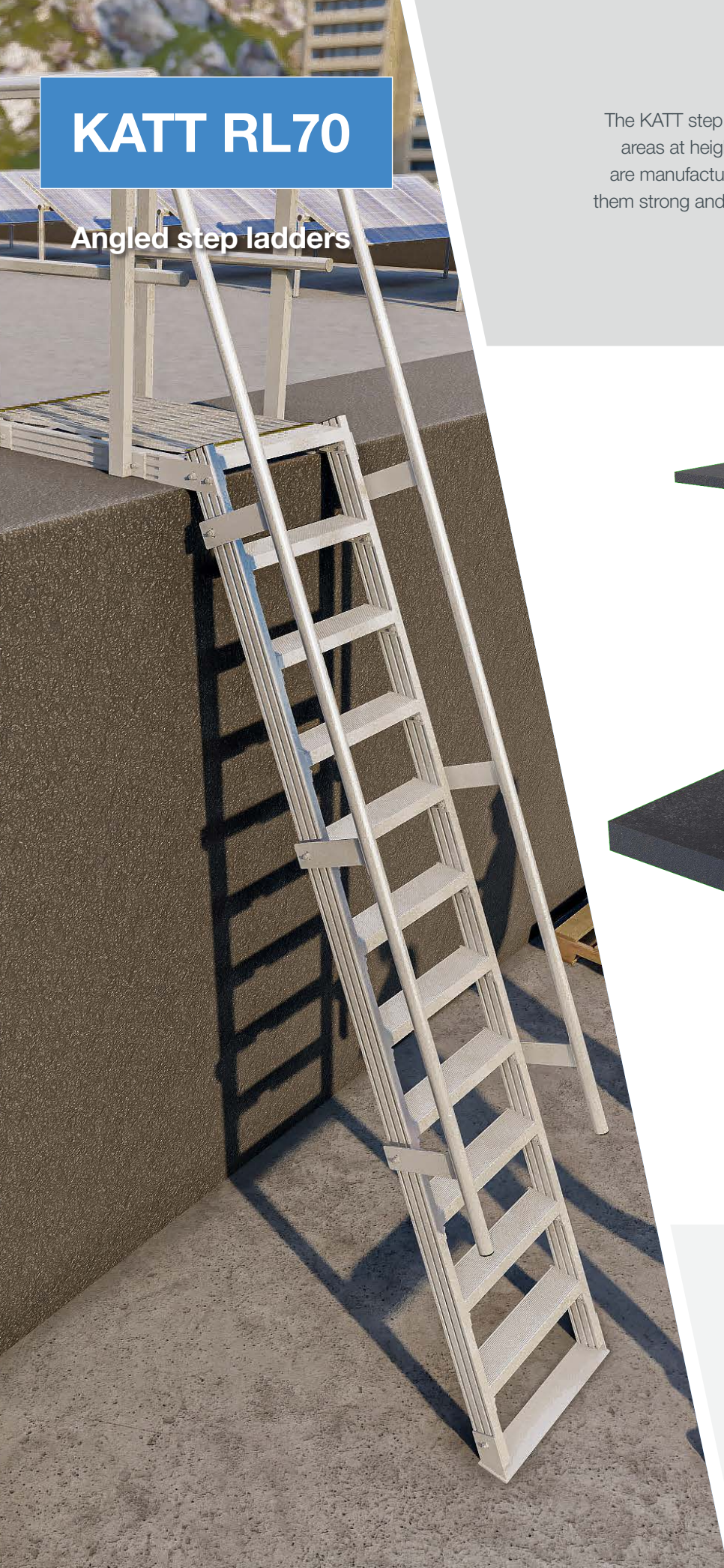

RL70 Angled step ladder

Standard modular stepped ladder with grabrails to be fitted to underside of roof hatch.





When do I need to add an intermediate platform?

An intermediate platform should be added to an RL70 ladder when height exceeds 3m.

Platform kits are available for all ladder variation and shown on page 19.



RL70.40 Angled step ladder with 400mm platform

Modular stepped ladder with grabrails and 400mm landing designed to attach to front face of structure or platform.



RL70.90 Angled step ladder with 900mm platform

Modular stepped ladder with grabrails and 900mm landing designed to attach to top of roof deck or structure.

RL70 LADDER COMMON APPLICATIONS

- Access to roof hatches
- Access to varying roof heights
- Safe Access over roof mounted machinery and dangerous zones

RL70 LADDER HEIGHT OPTIONS

RL70	RL70.40	RL70.90
1000mm	1000mm	1000mm
2000mm	2000mm	2000mm
3000mm	3000mm	3000mm



KATT CLIMB ACCESSORIES

Explore the range of accessories & extras suited to all ranges of the modular KATT ladders available.

Standard fixing bracket

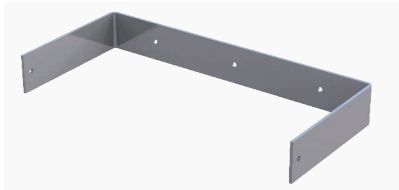

Code	Depth of bracket	Stand-off from wall
KSLBR.01.280	280mm	220mm

Gusseted fixing bracket

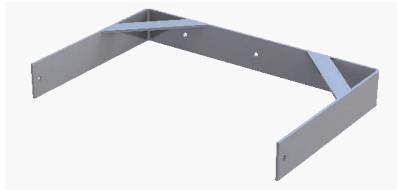

Code	Depth of bracket	Stand-off from wall
KSLBR.01.400	400mm	340mm

Adjustable fixing bracket

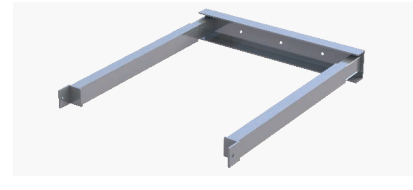

Code	Depth of bracket	Stand-off from wall
KSLBR.02.000	600-1000mm	540-940mm

Landing fixing Bracket

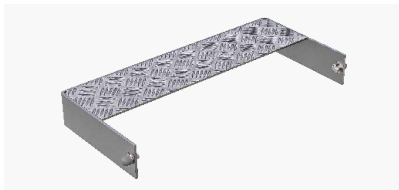

Code	Depth of bracket	Stand-off from wall
RL421L.280	280mm	220mm

Suspended fixing bracket



Code	Depth of bracket	Stand-off from wall
RL421S.280	280mm	220mm

Ladder base support angle set

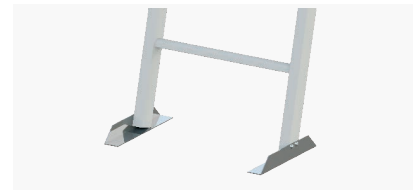

Code	Description
KSLBA.01.000	Ladder base support angle set for fixing to metal roof sheet and concrete decks

Ladder bridging plate



Ladder bridging checker plate for covering gap between top wrung and roof surface.

Code	Width	Depth
KL_BRIDGING_PLATE	500mm	380mm

Adjustable landing kit



Code	Description
KL-LANDING-ADJUSTABLE	Adjustable landing kit to provide a level landing for side entry onto pitched roofs.

Landing kit

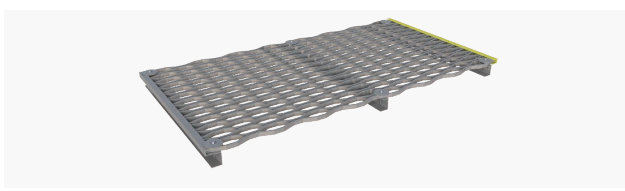

Code	Length	Depth
KL-LANDING-KIT	1000mm	600mm

Ladder head walkway kit



Code	Width	Length
KL-ACCESS-WALKWAY-2400	600mm	2.4m
KL-ACCESS-WALKWAY-3000	600mm	3.0m

Midway rest platform



Code	Depth	Width
KL-REST-MIDWAY-PLATFORM	1200mm	2400mm

Ladder base checker plate

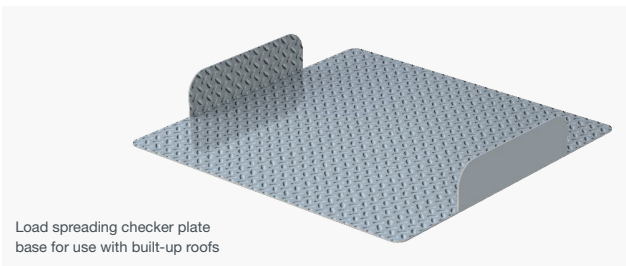

Code	Length	Depth
KSLBA.02.000	600mm	600mm

Ladder cage gate

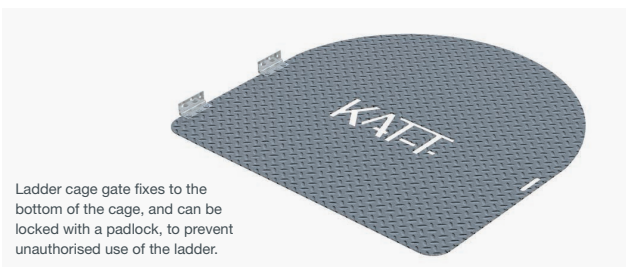

Code	Width	Depth
KSLSE.01.000	710mm	715mm

Ladder head walkway kit – adjustable

Adjustable walkway kit to provide a level landing for side entry onto pitched roofs.

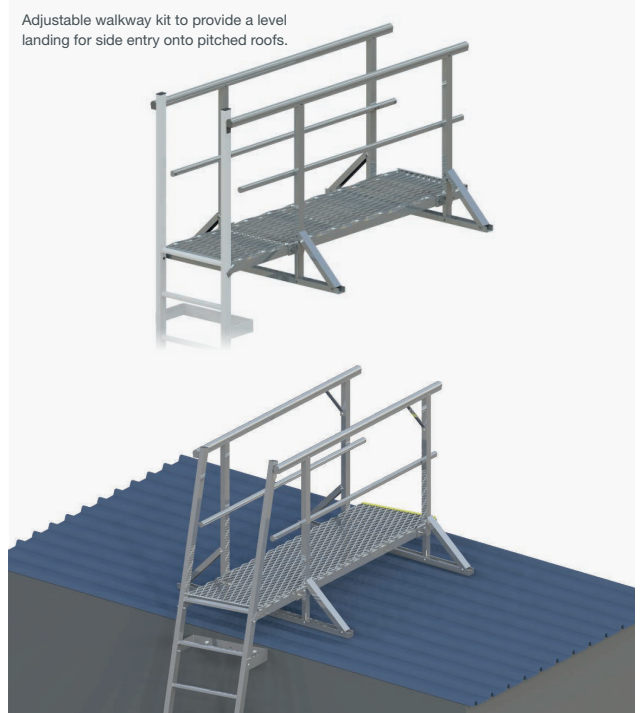

Code	Width	Length
KL-ACCESS-WALKWAY-2400-A	600mm	2.4m
KL-ACCESS-WALKWAY-3000-A	600mm	3.0m

Lockable ladder door



Code	Height
KSLSE.02.000	2400mm

KATT SUMMARY OF STANDARDS

1



Ladder must be fixed at between 90°–75°.

2

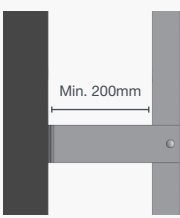

Minimum 200mm clearance required between ladder to wall, and minimum 150mm clearance required between ladder and a discontinuous obstacle.

3

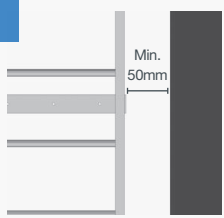

Minimum of 50mm hand clearance on the sides of the ladder except where the brackets are attached to the ladder.

4

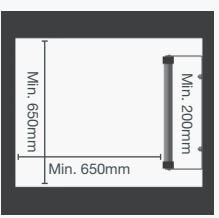

There must be a minimum of 200mm between the ladder and the wall. There must be minimum of 650mm clearance in front of the ladder and minimum of 650mm width clearance.

5

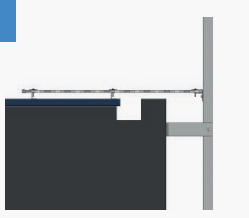

The upper surface of the top rung must be level with the landing platform.

6

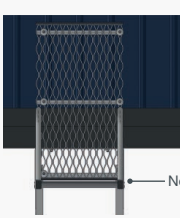

Top rung to landing. There shall be no gap, or maximum 75mm gap between the top rung and the landing platform.

7

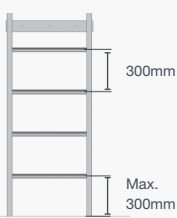

The rungs in a ladder flight must be uniformly spaced between 225–300mm. The distance between the departure area and the lowest rung must not exceed the spacing between 2 rungs.

8



Brackets must be fixed maximum 3m apart.
Note – ensure there is a bracket connected to each ladder section.

9



For ladders over 3m, fall protection must be provided. A cage is the preferred choice.

10

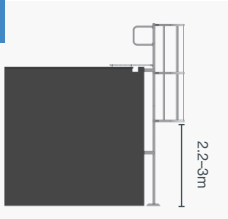

The lowest part of the cage must start at a height of between 2.2m and 3m above the departure area.

11

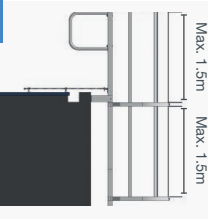

The distance between cage hoops must not exceed 1.5m.

12

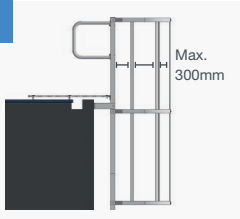

The distance between cage straps must not exceed 300mm.

13

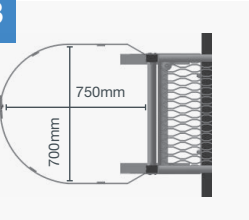

The clear distances within the hoops of the safety cage must be between 650mm and 800mm. The distance from the rung to the safety cage must be between 650mm and 800mm.

14

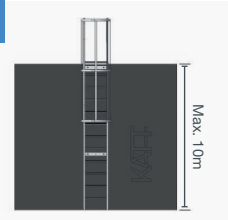

When the climbing height is 10m or less, one single flight ladder can be installed.

15

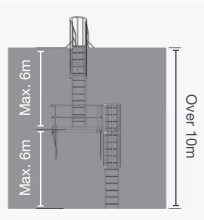

When the height is greater than 10m, a staggered flight ladder must be installed. The climbing height of the individual ladders must be 6m or less and an intermediate rest platform must be provided between each ladder.

16

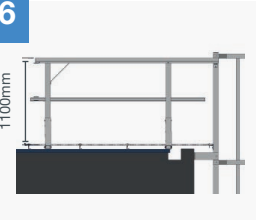

The distance between the landing platform and the handrail must be 1100mm, and the gap between the handrail and the knee-rail must not exceed 470mm.

TECHNICAL SPECIFICATIONS

MATERIALS

All components and accessories manufactured from high-grade structural aluminium with options for powder coating.

DIMENSIONS

- Overall ladder width – 605mm
- Distance between stiles – 525mm
- Rung diameter – 50 x 35mm (profiled)
- Rung spacing – 300mm
- Stile extension above landing surface – 1100mm
- Minimum clearance behind ladder – 200mm (vertical position)
- Maximum distance between rest platforms – 6M

CHARACTERISTICS

- Modular Design
- Lightweight
- Strong & Durable

QUALITY ASSURANCE

All KATT Climb components are manufactured by our ISO-9001 certified partners. KATT safety recognises the importance of all products being consistent in quality and regularly inspects the production process to ensure best quality products are produced.

WEIGHT

- Ladder body sections – 2.9kg/M (excludes fixing brackets and fixings)
- Cage sections – 8.3kg/M

WORKING LOAD LIMIT

- Recommended for single person use – 150kg rated.
- Industrial rated, suited to high frequency usage.
- Support structure integrity, suitability and fixing method to be assessed and determined by an engineer unless it is clear to a competent person prior to installation.

COMPLIANCE

KATT Ladder System is designed to comply with requirements of BS4211:2005 & BS EN ISO 14122-4:2016 and relevant statutory HSE guidelines.

PRODUCT WARRANTY

10 years from date of purchase subject to correct installation, use and maintenance, in accordance with manufacturer's specifications and recommendations.

INSPECTION AND MAINTENANCE

Inspection and certification required every 12 months by competent person, in accordance with manufacturer's specification and relevant HSE statutory guidelines.

IMPORTANT NOTE

Failure to supply and/or install proprietary product in accordance with above standards and codes, specifications and instructions, voids complete system certification and/or warranty.





KATT GUARD

ROOFTOP GUARDRAIL SYSTEMS

BENEFITS OF KATT GUARD SYSTEMS

- Lightweight, modular designed components for easy installation
- Customisable on site to suit requirements
- High strength Aluminium construction

Customisable permanent roof guardrail systems which are easily configured in the field to suit multiple applications.

KATT GUARD® modular roof guardrail systems ensure maximum safety for maintenance personnel while working on rooftops.

Manufactured from high-strength aluminium to withstand the harshest of weather conditions, these passive systems provide continuous fall protection, are simple and quick to install, and the modular design means these systems can be easily customized on-site to suit your requirements.

There are two series of guardrail solutions – Sentry fixed guardrail or EdgePro Free-standing weighted guardrail. Whether your looking for a guardrail that can be fitted to the side of a parapet wall, or a system that doesn't penetrate the roof surface - KATT GUARD has it all!



Fixed aluminium guardrail systems

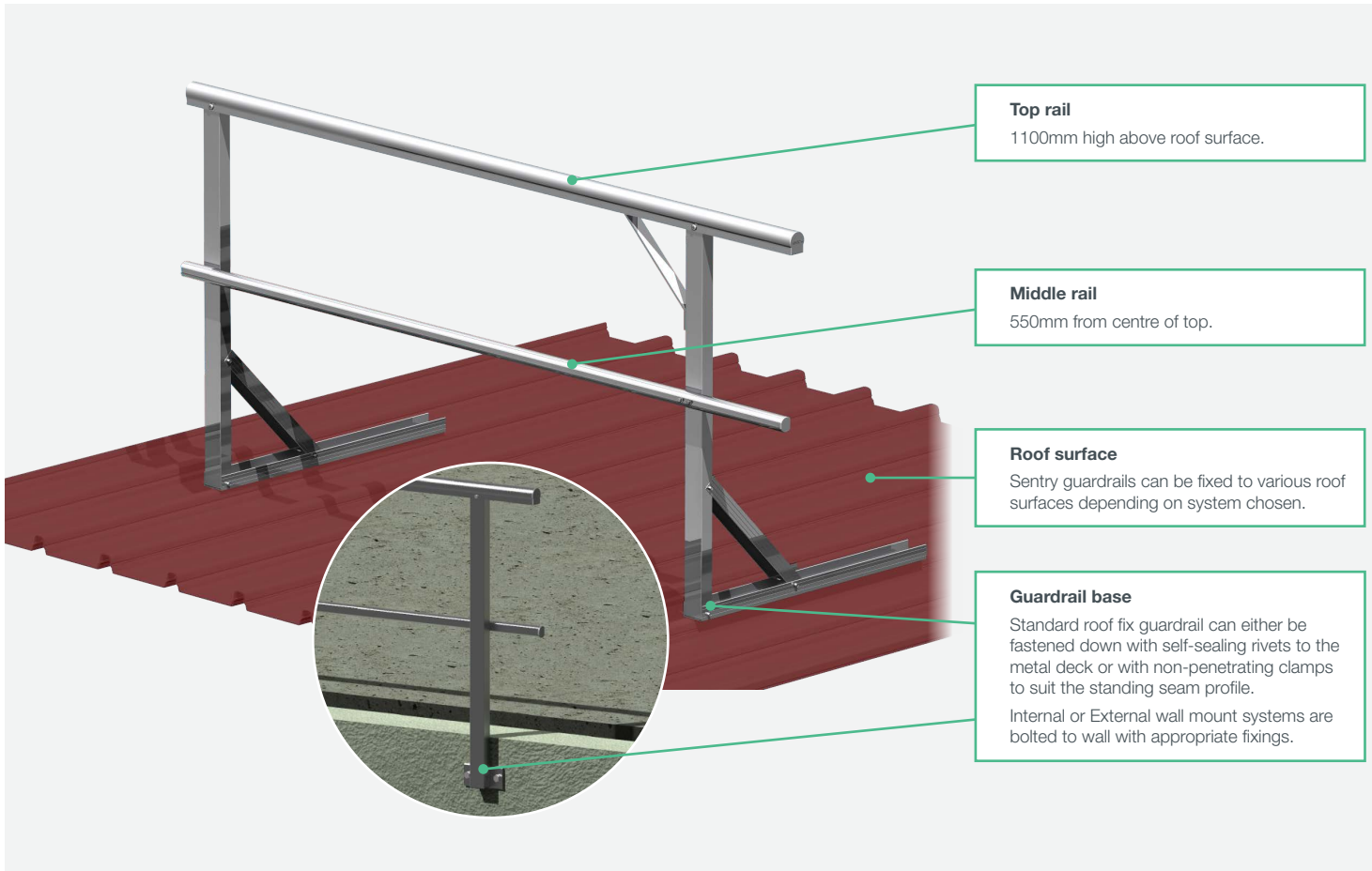

Free-standing roof guardrail systems

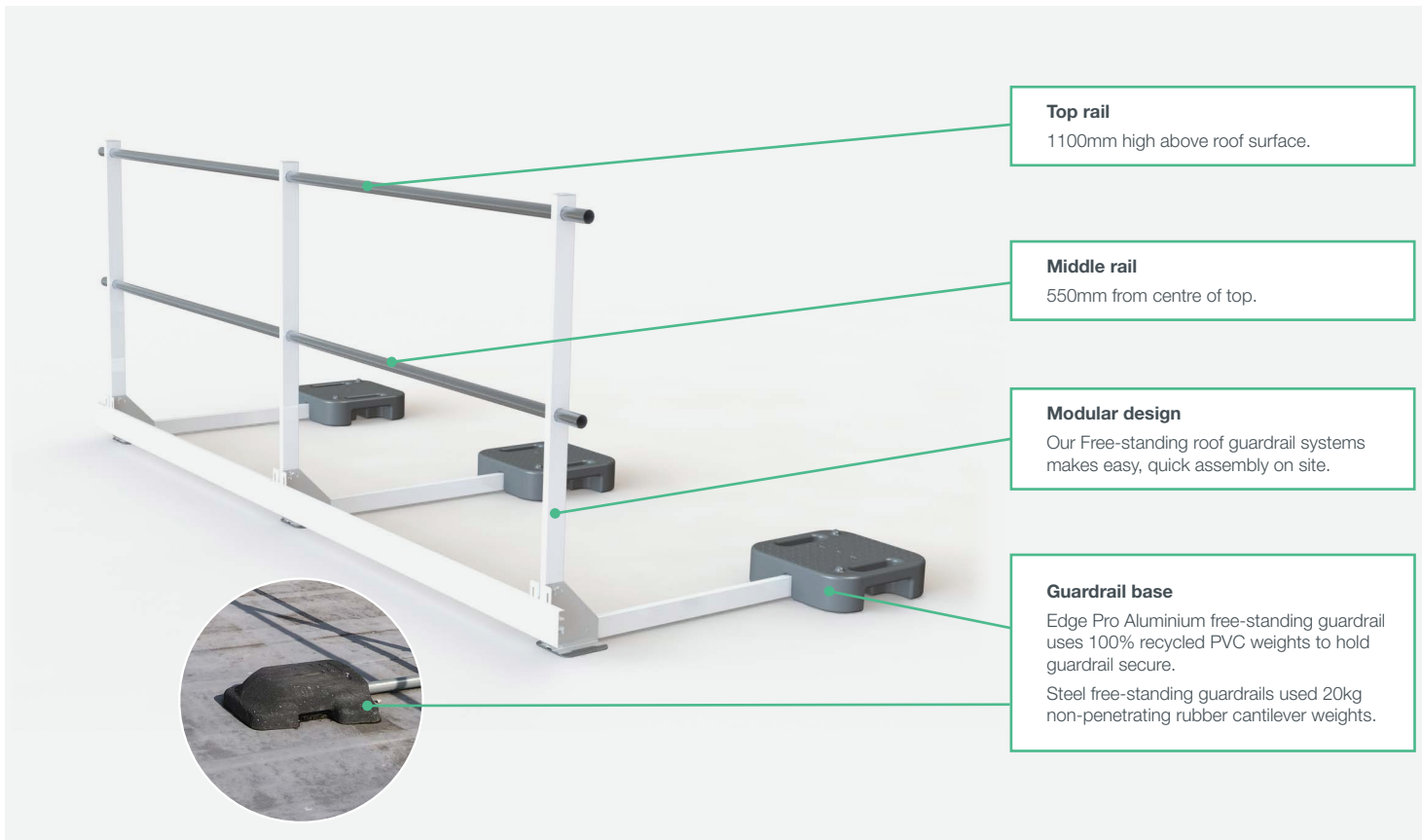

SENTRY GUARDRAIL SYSTEMS

Sentry guardrail corner

Sentry guardrail systems use a swivel corner joint enabling the guardrail to turn almost any angle.



Permanent fixed roof guardrail systems ensuring maximum safety at height.

Sentry is a best-in-class permanent guardrail system. It is manufactured from corrosion-resistant aluminium and is secured into the roof structure with rivets or self-drilling fasteners. It is quick and easy to install, with no need to lift counterweights to roof level.

Each Sentry Guard rail system is tailored to meet your exact requirements – from the swivel joints to the base design, it is fully adjustable to suit any location and roof design, where the pitch is under 10 degrees.

Sentry is compliant with BS EN ISO 14122:3:2016.



COLOUR OPTIONS

All KATT GUARD® systems are available in the following colours below.

IN STOCK

Mill

Yellow

Bronze

Black

Almond

And also available to be powder coated in most other RAL colours!

Standard roof fix guardrail

The metal roof mount guardrail system is designed for fixing to metal roofs, including R panel and standing seam systems.

Guardrail can be fixed with self-sealing rivets to metal deck or with non-penetrating clamps to suit the standing seam profile.



What centres should the posts be?

Posts on all Sentry guardrail systems should not be more than 2m centre to centre.



Internal wall mount guardrail

Guardrail system which fixes to internal wall of building, usually to parapet wall. Multiple configurations available due to modular design.

Options of single rail or double rail available depending on height of wall.



External wall mount guardrail

Guardrail system which fixes to external wall of building. Easily adaptable to your project due to modular design.

Extras available including toe boards for extra safety.

GUARDRAIL REQUIREMENTS

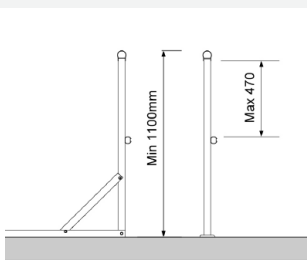

Guardrail height

Minimum height for guard railing is 1100mm from the roof surface.

If guardrail is more than 1100mm high, a third rail is required.

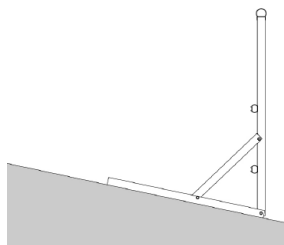

Guardrail on Sloping Roofs

If there is guardrail on the edge of the roof where the slope is 12° or greater, a third rail is recommended.

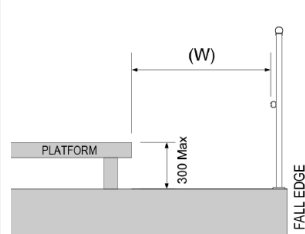

Guardrail on platforms

Guardrail is not required on a platform if the height to lower landing is less than 300mm and (W) is not more than 1000mm.

If (W) is less than 1000mm then the guardrail height must be increased by 300mm.

If platform is higher than 300mm, guard railing is required on the platform.

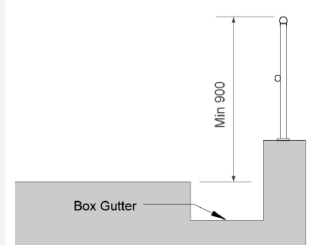

Guardrail on parapet

Height of guardrail must be min 1100mm from main roof surface e.g. roof deck. (Unless box gutter is more than 1000mm wide - then height is measured from box gutter)

FREE STANDING GUARDRAIL SYSTEMS

The roof guardrail solutions providing ultimate roof edge protection without the need for structural work.

The free-standing roof guardrail systems are the perfect solution when needing a guardrail but cannot penetrate the roof surface. There are two versions of guardrails available, one formed from galvanised steel and our other system is formed from High strength Aluminium. Both systems follow the same principle of being held in place by using cantilever weights.

The Modular design makes these systems very easy to install with post supplied pre-assembled, this system can be ready to protect lives in no time.



Did you know we do take-offs from drawings?

Send us a drawing of your roof space and we will work out the parts required to ensure your roof area is safe and compliant for years to come.





Aluminium free-standing roof guardrail

The non-penetrating aluminium free standing roof guardrail system uses recycled PVC counterweights to hold the handrail in position.

The simple modular design enables many configurations to be created.

Posts are spaced every 2m maximum.

This system has been tested and complied to BS EN 13374:2013 & BS 13700:2021

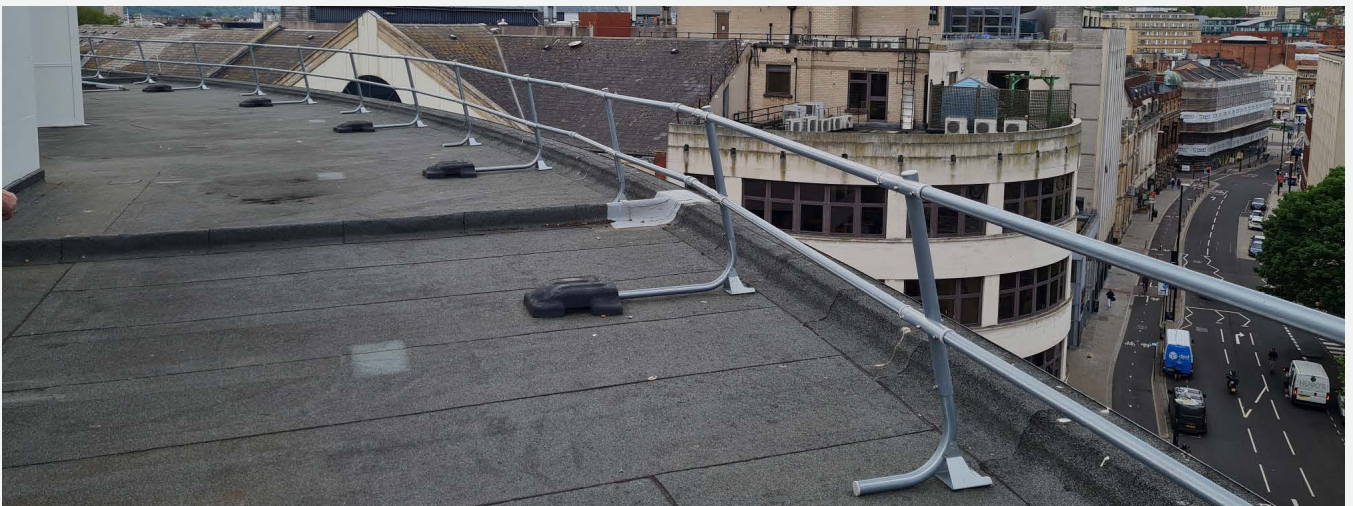

Galvanised steel free-standing roof guardrail

No need to penetrate the roof surfaces, the free standing steel roof guardrail system uses 20kg counterbalanced rubber weights to hold the handrail in position.

Posts are spaced every 2.5m maximum.

This systems has been tested and complies with BS EN 13374:2013

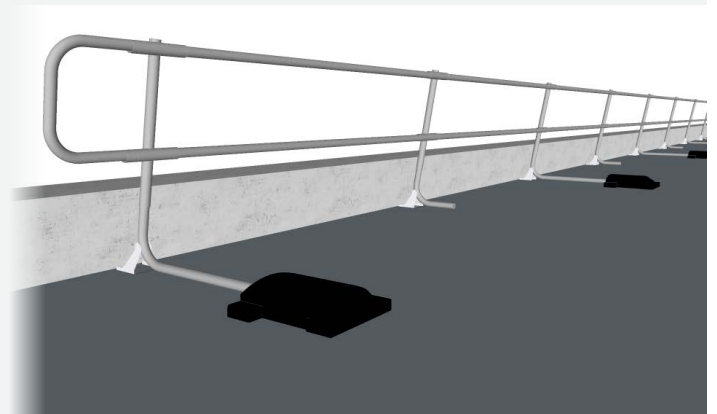

KATT GUARD ACCESSORIES

Range of accessories & extras available with all KATT Guard modular rooftop guardrail systems.

Fixing Sets



Nylon anchors sets & resin anchor stud sets available for fixing brackets to block / brick surfaces.

Toggle Bolt



Used to fix brackets to hollow walls / surfaces.
300mm bolt shown - More sizes available

Roof panel mounting kit



GR32 guardrail fastening kit for roof panel metal roof profiles.

Corner Kit



The corner kit includes (1) post kit, (1) top rail elbow, (1) midrail elbow, (1) brace and hardware

Buffalo XPSF polyester resin



Cartridges available in 300ml or 410ml and include nozzle for application.
Recommend 1 cartridge per 2 hardware kits

Wall Mount Bracket Kit



Post and wall mount bracket kit.
Includes screws, end cap, handrail screws and kneerail screws

Standing seam mounting kit



GR32 guardrail non-penetrating clamp kit for standing seam roof profiles
1 x kit required per post & corner kit

Metal roof post kit



Single guardrail post kit for GR32 guardrail for metal roofs

Guardrail toeboard kits



Toeboard kits available for many of Sentry guardrail systems.
Accessories for corners & returns available



Roof Hatch Access and Guardrail System

Our roof hatch access and guardrail systems are the complete package to provide means of safe, reliable access to roof top areas and fall protection at the access point.

The modular design means these guardrails can be fitted to your project in no time, with items supplied in kit form ensuring your job is as easy as possible when fitting.

Roof hatch Guardrails are available with standard mill colour rails or yellow powder coated rails from stock. Bespoke colours available on longer lead time.

TECHNICAL SPECIFICATIONS

For Sentry Guardrail Systems

MATERIALS

- Post Assemblies, Hand & Kneerails – Extruded high grade structural (6106/T6) aluminium with options for powder coating
- Universal Elbows & End Caps – Die cast aluminium

DIMENSIONS

- Handrail Component – 50mm diameter section mounted 1000mm to 1100mm above floor surface
- Kneerail Component – 40mm diameter section mounted 450mm below handrail
- Post Component – 60mm x 40mm RHS section, post length 950mm to 1100mm above floor surface
- Post Spacing – Max 2.0m intervals

CHARACTERISTICS

- Modular Design
- High Strength Aluminium construction
- Lightweight components
- Strong & Durable

QUALITY ASSURANCE

All KATT Guard components are manufactured by our ISO-9001 certified partners. KATT Safety recognises the importance of all products being consistent in quality and regularly inspects the production process to ensure best quality products are produced.

WEIGHT

2kg / m (approximate)

WORKING LOAD LIMIT

1200N applied horizontally mid span between posts of 2.0m spacing.

COMPLIANCE

KATT Guardrail Systems are designed and tested to comply with requirements of BS EN ISO 14122-3:2016 and relevant statutory HSE guidelines.

PRODUCT WARRANTY

10 years from date of purchase subject to correct installation, use and maintenance, in accordance with manufacturer's specifications and recommendations.

INSPECTION AND MAINTENANCE

Inspection and certification required every 12 months by competent person, in accordance with manufacturer's specification and relevant HSE statutory guidelines.

IMPORTANT NOTE

Visual inspection for any damage or loose fixings must be done periodically and prior to use. No certified maintenance is required. Basic wear and tear preventative maintenance is recommended, as per manufacturer's specifications and recommendations. (Refer instruction manual.)





KATT

WALK

MODULAR WALKWAY SYSTEMS

BENEFITS OF KATT WALK SYSTEMS

- Lightweight, modular designed components for easy installation
- Multi-directional, non-slip walkway surface
- Non-corrosive materials provide maintenance free protection
- High strength Aluminium construction

KATT modular walkway systems provide safe, designated access routes around rooftops.

KATT WALK® aluminium modular walkway systems are safe, durable and provide clear demarcation routes for the maintenance of rooftops and services.

These systems are designed to ensure safe working at height and can help protect fragile roofs. Manufactured from quality, high-strength aluminium means the modular pieces are non-corrosive, easily customizable in the field and are available in multiple configurations to suit almost any scenario as well as being lightweight and therefore easy to assemble.

The KATT WALK systems works seamlessly with the KATT GUARD guardrail to provide safe access solutions on both metal and membrane roof systems ensuring you can effectively manage work at height risks.



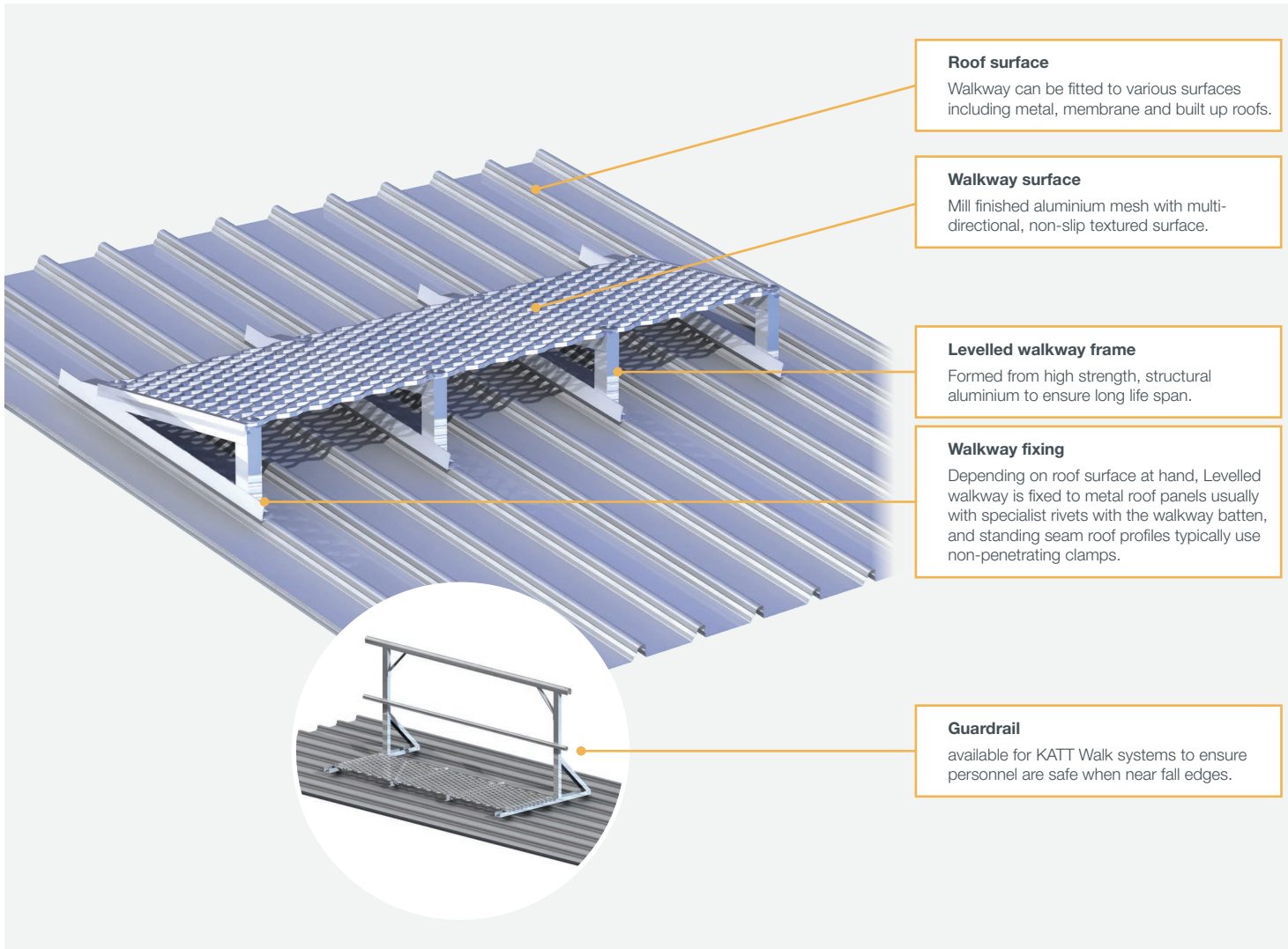

Roof surface

Walkway can be fitted to various surfaces including metal, membrane and built up roofs.

Walkway surface

Mill finished aluminium mesh with multi-directional, non-slip textured surface.

Levelled walkway frame

Formed from high strength, structural aluminium to ensure long life span.

Walkway fixing

Depending on roof surface at hand, Levelled walkway is fixed to metal roof panels usually with specialist rivets with the walkway batten, and standing seam roof profiles typically use non-penetrating clamps.

Guardrail

available for KATT Walk systems to ensure personnel are safe when near fall edges.

WALKWAY REQUIREMENTS

Walkway across slope

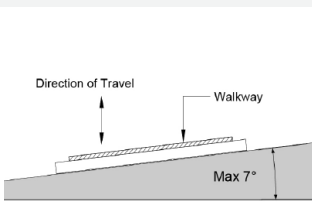

Roof Angle: 0 - 7 Degrees

If roof angle is between 0° - 7° the walkway can be the same angle as the roof.

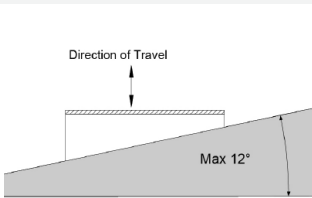

Roof Angle: 7 - 12 Degrees

If roof angle is between 7° - 12° the walkway surface must be levelled to be compliant with British regulations.

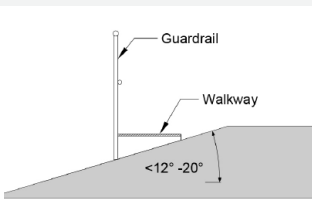

Roof Angle: >12 - 20 Degrees

If roof angle is around 12° or greater the walkway surface must be levelled and a guardrail must be fitted to ensure safe access and to be compliant with British regulations.

Walkway in-line with slope

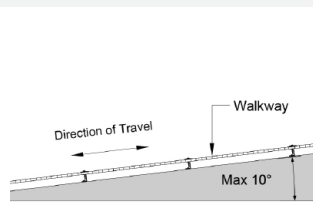

Roof Angle: 0 - 10 Degrees

If roof angle is between 0° - 10° the walkway can be the same angle as the roof.

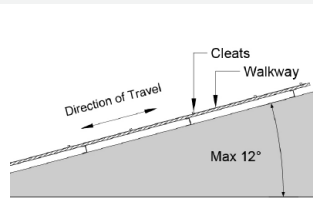

Roof Angle: >10 - 12 Degrees

If roof angle is between 10° - 12° the walkway surface can be same angle as roof but cleats are required.

Cleat Spacings:

- Slopes 10° - 15° = every 450mm
- Slopes 15° - 18° = every 400mm
- Slopes 18° - 20° = every 350mm

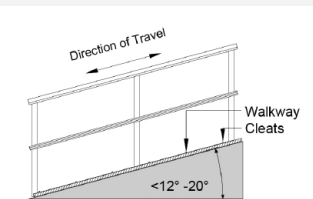

Roof Angle: 12 - 20 Degrees

If roof angle is between 12° - 20° or greater the walkway is same angle as roof, cleats are required and guardrails on both sides to ensure safe access and to be compliant with British standards.

PACE WALKWAY SYSTEMS

Modular designed fixed walkway systems providing safe access routes for workers.

Pace is a lightweight yet strong aluminium walkway system with a modular design that can be tailored to your exact requirements, while being simple to assemble.

Manufactured from high-strength, structural aluminium these walkway systems are corrosion resistant and supplied with 10 year warranty for extra peace of mind.

Available in multiple configurations depending on scenario, available with guardrails as an extra to ensure your workers are safe when working at height.

FEATURES OF PACE WALKWAY SYSTEMS

- Sturdy, heavy duty aluminium construction - Low maintenance
- Provides a controlled access pathway for workers on roofs
- Fixes to standing seam roofs or to R panel roof systems
- Can be mounted on membrane and built-up roof systems
- Tested and complies with BS EN ISO 14122-3:2016 / BS 4592 & BS EN 516



AVAILABLE
FROM STOCK
FOR PROMPT
DELIVERY
TO SITE!

Non-Slip Walkway surface

Pace aluminium walkway systems are designed and manufactured with multi-directional, non-slip walkway surface to ensure safe access across roof tops.



What centres should the battens be?

Battens on all Pace walkway systems should not be greater than 700mm centre to centre.

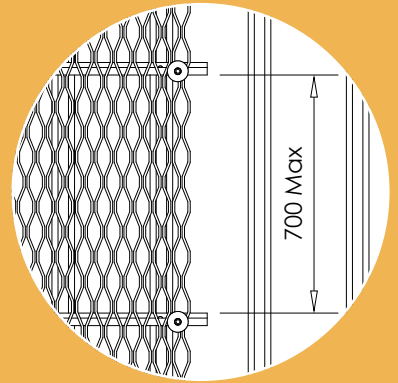

GW8 Standard walkway system

Fixed Aluminium walkway system used on roofs less than 7°.

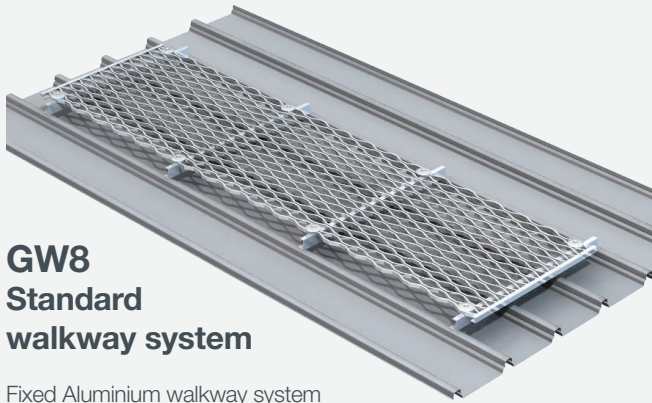

GW4 Standard walkway with single guardrail

Fixed aluminium walkway with guardrail on one side for fall protection.

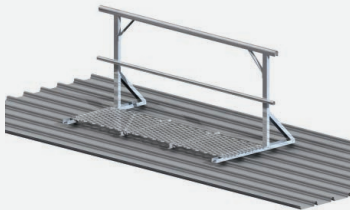

GW6 Standard walkway with double guardrail

Fixed aluminium walkway with guardrail on both sides for fall protection.



GW9 Levelled walkway system

Fixed Aluminium levelled walkway system commonly used on roofs with angle greater than 7°.

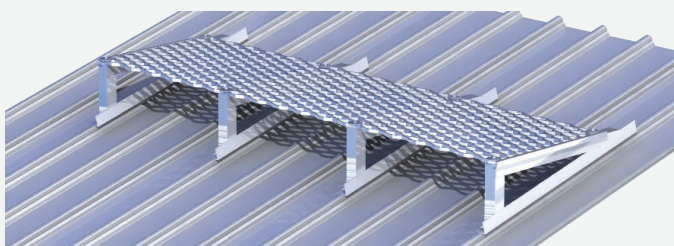

GW5 Levelled walkway with single guardrail

Fixed levelled aluminium walkway with guardrail on one side for fall protection.



GW7 Levelled walkway with double guardrail

Fixed levelled aluminium walkway with guardrail on both sides for fall protection.



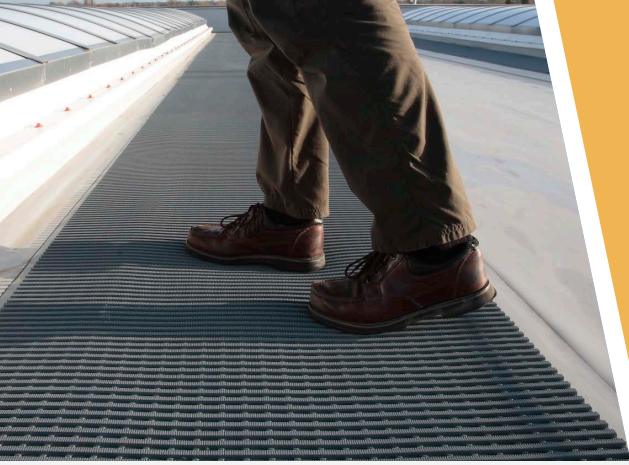

DUKMAT LOOSE LAY WALKWAY

BENEFITS OF DUKMAT WALKWAY SYSTEM

- Easy installation process that requires no permanent fixing equipment or materials.
- Stable and durable construction that remains stable even in 60mph winds (96km/h).
- Permanent slip resistance that protects you and your employees from injury.
- Protective construction that prevents your roof membrane from being damaged or pierced.
- An open grid format designed to encourage maximum drainage.

Non-Penetrating Flexible Walkway Systems for almost any roof system

When you need a safe all-weather walkway mat with easy installation, choose DukMat for your roof system!

DukMat can be installed in seconds and provides complete roof membrane protection. Unlike other systems, the DukMat only needs cable ties for installation — no specialised equipment required. Once it's been carefully placed in the desired position, a DukMat flexible walkway is stable enough to handle hurricane-force winds. This walkway system is designed to cause no harm to your roof and protects your roof membrane against damage for many years to come. DukMat is compatible with many roofing surfaces including PVC, bitumen, GRP and coated steel roofs.

Is DukMat Tested?

DukMat walkway system has been tested for slip resistance and is certified as per DIN 51130: R10.

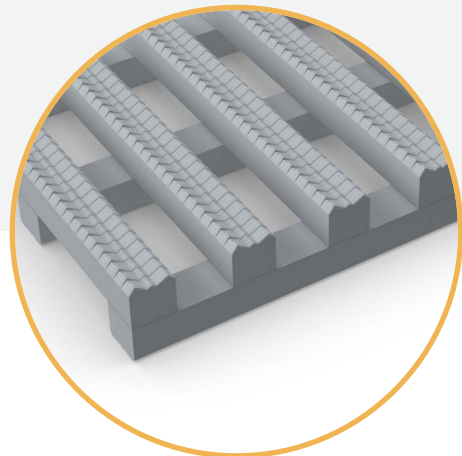

WIDTH OPTIONS

600mm
910mm
1220mm

DUKMAT Loose lay walkway

Non-penetrating walkway system with non-slip surface for safe access.

Supplied in rolls of 10m lengths, available in various and widths as shown.

COLOUR OPTIONS

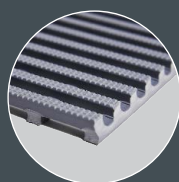

Grey

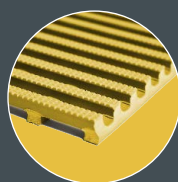

Yellow

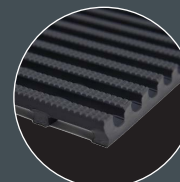

Black

TECHNICAL SPECIFICATIONS

For Pace Walkway Systems

MATERIALS

- Walkway – mill finish, expanded aluminium grating
- Roof battens – mill finish profiled aluminium

DIMENSIONS

- Walkway grating length - 3000mm/6000mm
- Walkway grating width - 600mm mounted 450mm below handrail
- Walkway grating thickness - 13mm
- Support batten - 700mm(L) x 40mm(H)

CHARACTERISTICS

- Modular Design
- High Strength Aluminium construction
- Lightweight components
- Multi-directional, non-slip walkway surface
- Non-corrosive materials provide maintenance free protection

QUALITY ASSURANCE

All KATT Walk components are manufactured by our ISO-9001 certified partners. KATT Safety recognises the importance of all products being consistent in quality and regularly inspects the production process to ensure best quality products are produced.

WEIGHT

- 4.5 kg per linear metre (6.4kg per m²)
- Roof battens – mill finish profiled aluminium

WORKING LOAD LIMIT

Span (mm)	Max load capacity	Max deflection
500mm	4.8 kPa	2.5mm
670mm	2.5 kPa	3.2mm
700mm	1.8 kPa	3.5mm

COMPLIANCE

- KATT Walkway Systems are designed and tested to comply with requirements of BS EN ISO 14122-3:2016 and relevant statutory HSE guidelines.
- Walkway surface has been tested and complies with BS EN 516:2006.

PRODUCT WARRANTY

10 years from date of purchase subject to correct installation, use and maintenance in accordance with manufacturer's specifications and recommendations.

INSPECTION AND MAINTENANCE

- Visual inspection for any damage or loose fixings must be done periodically and prior to use.
- Basic wear and tear preventative maintenance is recommended, as per manufacturer's specifications and recommendations.

IMPORTANT NOTE

Failure to supply and/or install proprietary product in accordance with above specifications and installation / usage guidelines voids complete system certification and/or warranty.





KOMBI® MODULAR

MODULAR ACCESS SYSTEMS

BENEFITS OF KATT WALK SYSTEMS

- Lightweight, modular designed components for easy installation
- Customisable on site to suit exact site requirements
- High strength Aluminium construction
- Designed in accordance with UK standard BS EN ISO 14122:2016

Lightweight, high strength aluminium modular access systems allowing endless design and installation flexibility.

KOMBI® Modular aluminium stair, platform, stepover & walkway systems make access to elevated assets and equipment easy and safe for many years to come.

These systems are designed to allow for quick on-site assembly, constructed using a standard range of aluminium components meaning it is lightweight and enables many configurations to be assembled to suit your exact site parameters, and therefore reducing design and delivery lead times considerably.

KOMBI is the safest solution for access and fall protection, formed from high-strength, structural grade aluminium, these systems are not only built to last in all kinds of conditions but designed in accordance with UK standard BS EN ISO 14122:2016.



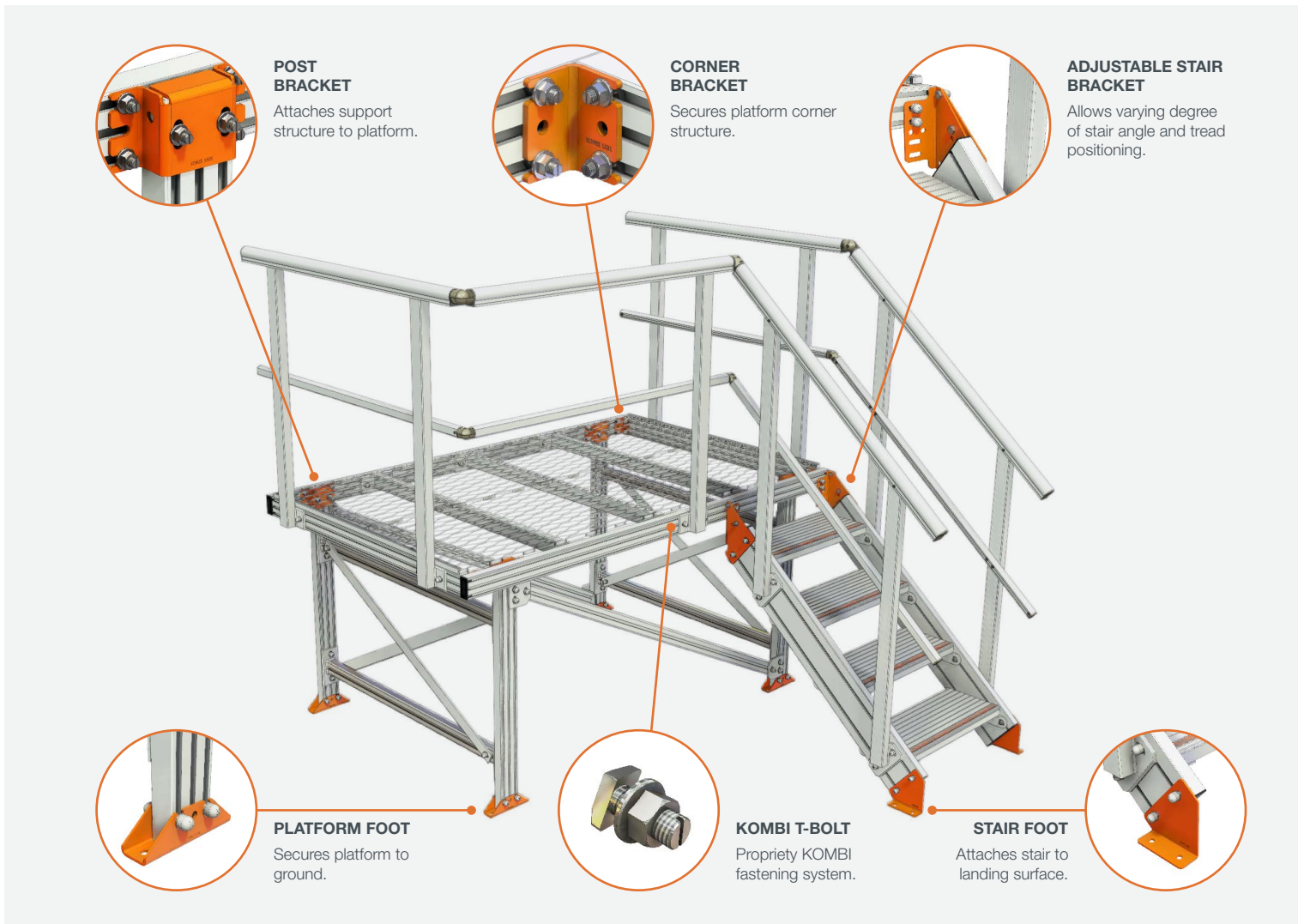

1. SUPPORT MODULE

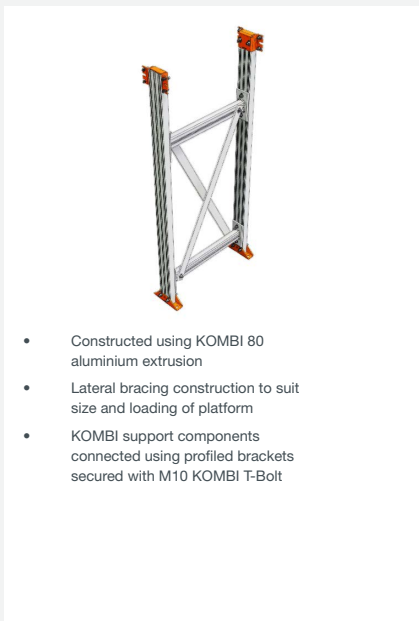

2. PLATFORM MODULE



3. STAIR MODULE

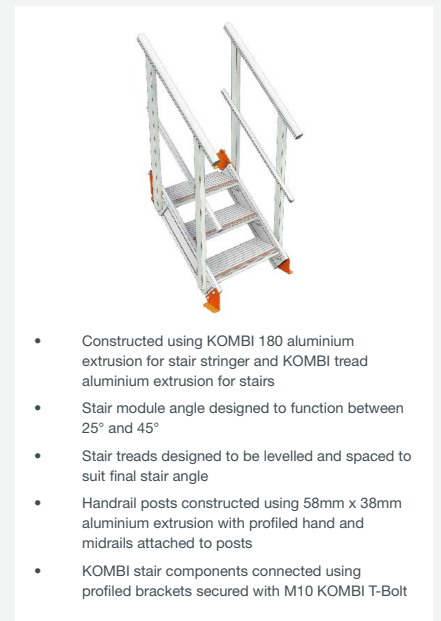



KOMBİ SYSTEMS

Modular access systems for providing safe access to elevated assets, structures and equipment.



STAIRS

Aluminium stairway system

Fully modular stair sets suitable for heights up to maximum of 6m.



STEPOVERS

Aluminium stepover with dual stairs

Modular Access Stepovers provide safe, easy access routes over ducts, walls and machinery such as conveyors.

Many configurations available with bridge lengths available from 1m up to 6m.

Modular component assembly means these stepovers have fully adjustable stair heights to suit your required bridge height.

Available as fixed or free-standing.

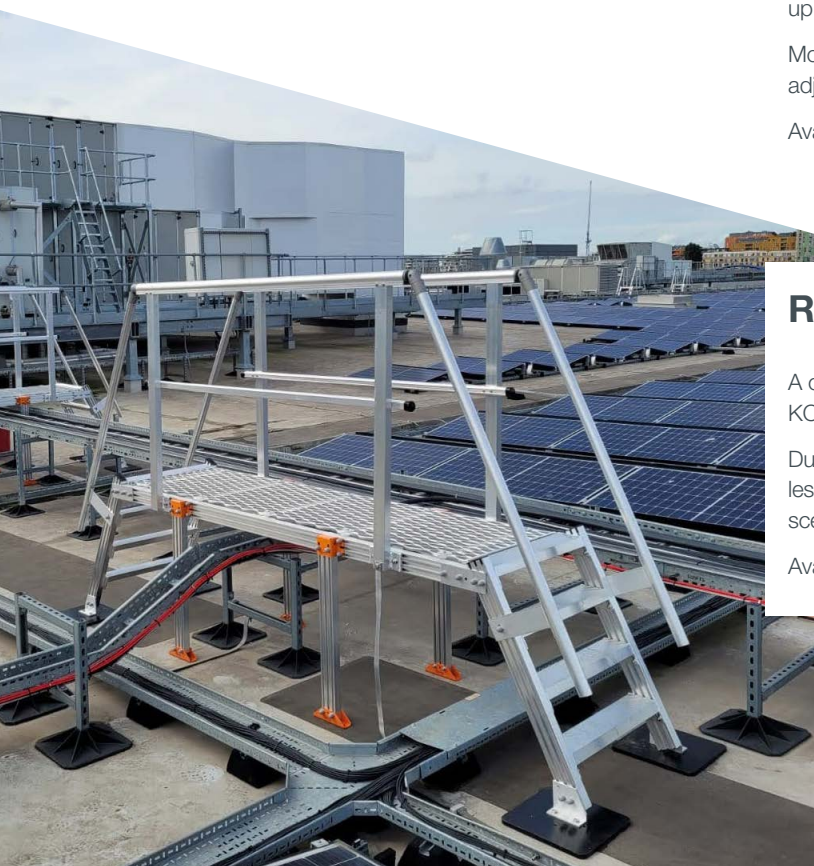

RL70 STEPOVERS

A compact, modular stepover formed from RL70 ship ladder and KOMBİ platform products.

Due to the use of the stepped ladder sections, this stepover uses less space than standard KOMBİ stepovers making it ideal for scenarios where space is limited.

Available as fixed or free-standing.



Want to know the Secret?

The unique self-locking KOMBI T-Bolt is the main fixing used across all KOMBI systems. The bolt twists and locks within the components making the system strong and secure for many years to come.



PLATFORMS

Aluminium access platforms

Modular Access Platforms for quick, easy access to machinery and elevated equipment for inspection and maintenance.

Platform size and height is adjustable to suit specific site requirements.

Suited to free-standing construction where required.

WALKWAYS & STRUCTURES

Purpose built access structures

Modular access walkways & structures enabling access around and above heavy machinery, cooling towers, water tanks and more.

The modular component design facilitates on-site construction allowing site specific design flexibility and attachment to structure

The KOMBI high strength bracing system allows platforms to be free standing up to 6.0m.



KOMBI systems designed to comply with
BS EN ISO 14122:2016



KOMBI COMPONENTS

KOMBI components include a combination of stainless steel profiled support brackets and aluminium platform beams, support posts and stair tread extruded profiles.

For simplified construction, the unique KOMBI T-Bolt allows insertion and fixture through the face of the profiled support brackets into the fixing slot of the extrusion.

All KOMBI components are proprietary to the system and designed to be used in multiple applications and configurations.

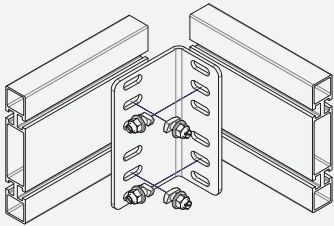

KB013.180

KOMBI 180 WITH ANGLE BRACKET

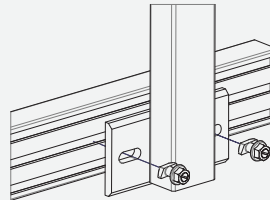

KB603S

KOMBI SIDE MOUNT POST KIT

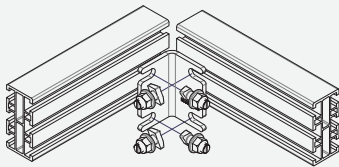

KB013.80

KOMBI 80 WITH ANGLE BRACKET

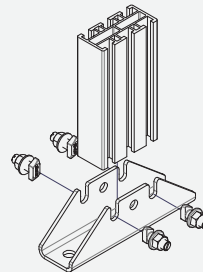

KB026

KOMBI 80 WITH BASE SUPPORT FOOT

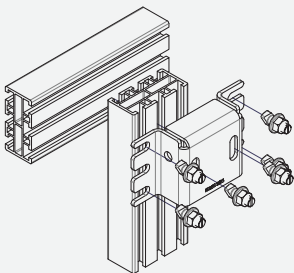

KB021

KOMBI 80 WITH TOP SUPPORT BRACKET

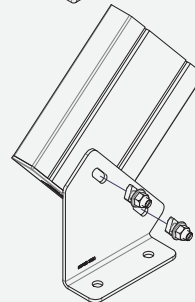

KB034

KOMBI STAIR WITH FOOT 180MM ADJUSTABLE

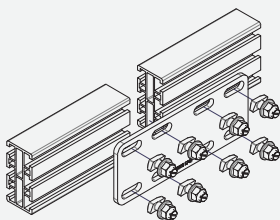

KB016.80

KOMBI 80 WITH POST JOINING PLATE

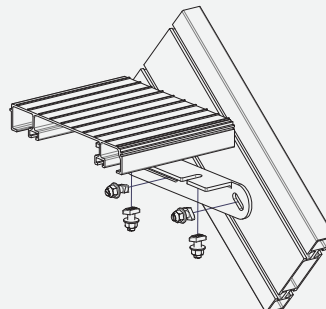

KB019

KOMBI STAIR TREAD WITH CONNECTION BRACKET

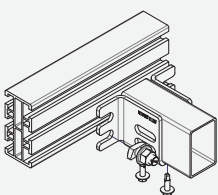

KB012

KOMBI 80 WITH HORIZONTAL SUPPORT BRACKET

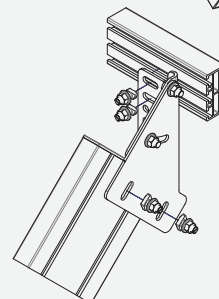

KB031

KOMBI STAIR MOUNTING WITH ADJUSTABLE BRACKET



Needing a free standing system?

KOMBI systems can be supplied with 12kg weighted bases to hold them securely in position and not penetrate the surface.

Bases are 315 x 315 x 15mm in size and available to be fitted to most KOMBI Systems.



No.	CODE	DESCRIPTION
1	GW382	HANDRAIL ELBOW
2	GW383	KNEERAIL ELBOW
3	KSUHA.01.000	HANDRAIL TUBE
4	KSUKN.01.000	KNEERAIL TUBE
5	GW351S	GUARDRAIL POST SIDE MOUNT
6	KB601R/L	STAIR HANDRAIL POST
7	KSUHA.01.000	STAIR HANDRAIL TUBE
8	KSUKN.01.000	STAIR KNEERAIL TUBE
9	GW378	HANDRAIL END CAP
10	GW379	KNEERAIL END CAP
11	KSUEX.05.000	KOMBI 180 EXTRUSION
12	KB010.0610	STAIR TREAD
13	KB034	STAIR ADJUSTABLE FOOT

No.	CODE	DESCRIPTION
14	KB026	BASE SUPPORT BRACKET 80MM
15	KSUEX.04.000	KOMBI 80 EXTRUSION
16	KB530.0900	SUPPORT BRACE
17	KB021	TOP SUPPORT BRACKET 80MM
18	KB013.80	BRACE SUPPORT BRACKET
19	KB005	KOMBI T-BOLT
20	KSUTB.01.000	TOE BOARD
21	KB013.80	ANGLE BRACKET 80
22	KSUWA.01.000	PLATFORM MESH
23	KB060.06	PLATFORM CROSS SUPPORT
24	KB031	STAIR MOUNT BRACKET
25	KSUED.01.000	PLATFORM MESH EDGE BAR

KOMBI ASSURANCE

KOMBI platforms and stairs are designed in accordance with UK standard BS EN ISO 14122:2016

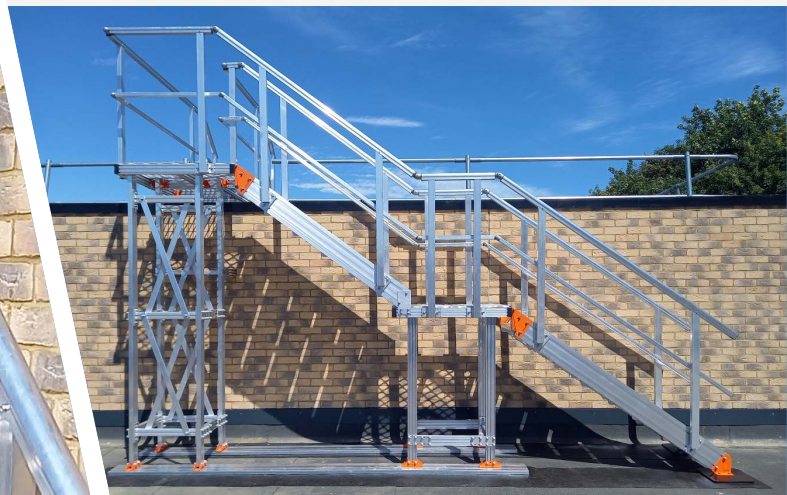

KOMBI Modular Stairs Summerdown SEN School, Eastbourne



Having worked with the guys at KATT Safety on previous projects they have always gone above and beyond to help. The knowledge and support even when pricing is really helpful.

Here at Industrial Construction Sussex we use access ladders on regular projects and they are great products with clear instructions for installation.

The large stair we recently installed was a great bit of kit, this is the largest access stair we have supplied and installed to date. It came semi pre built in sections we just had to bolt together.

The units and ladders are extremely well built and sturdy, all of our installers find them good to install.

Industrial Construction Sussex Ltd



KOMBI TECHNICAL SPECIFICATIONS

MATERIALS	<ul style="list-style-type: none">• Manufactured from high grade structural aluminium• KOMBI fixing brackets, joining plates and support feet manufactured from profiled stainless steel plate powder coated burnt orange• KOMBI T-Bolt manufactured from stainless steel
DIMENSIONS	<ul style="list-style-type: none">• KOMBI 80 extrusion: 80 x 38mm• KOMBI 180 extrusion: 180 x 32mm• Platform support extrusion: 58 x 38mm• Stair tread: 250 x 40mm• Handrail post extrusion: 58 x 38mm• Aluminium expanded mesh: 600 x 13mm
FIXINGS	<ul style="list-style-type: none">• KOMBI T-Bolt: M10 x 25• Tek screw: 12g stainless steel
WEIGHT	<ul style="list-style-type: none">• KOMBI 80 extrusion: 2.6kg/m• KOMBI 180 extrusion: 4.0kg/m• KOMBI platform deck (aluminium mesh only - 600mm wide): 4.2kg/m²• KOMBI stair tread: 3.9kg/m
WORKING LOAD LIMIT	<ul style="list-style-type: none">• KOMBI platforms are designed to AS1657-2018 (Platform working load limit 2.5kPa)• KOMBI stairs are designed to AS1657-2018 (Stair working load limit 2.5kPa)
CHARACTERISTICS	<ul style="list-style-type: none">• Modular Design• High Strength Aluminium construction• Unique, self-locking KOMBI T-Bolt assembly• Lightweight components• Strong & Durable
QUALITY ASSURANCE	<p>All KOMBI components are manufactured by our ISO-9001 certified partners. KATT Safety recognises the importance of all products being consistent in quality and regularly inspects the production process to ensure best quality products are produced.</p>
COMPLIANCE	<p>KATT Guardrail Systems are designed and tested to comply with requirements of BS EN ISO 14122:2016 and relevant statutory HSE guidelines.</p>
PRODUCT WARRANTY	<p>10 years from date of purchase subject to correct installation, use and maintenance, in accordance with manufacturer's specifications and recommendations.</p>
INSPECTION AND MAINTENANCE	<p>Inspection and certification required every 12 months by competent person, in accordance with manufacturer's specification and relevant HSE statutory guidelines.</p>
IMPORTANT NOTE	<p>Failure to supply and/or install proprietary product in accordance with above standards and codes, specifications and instructions voids complete system certification and/or warranty.</p>

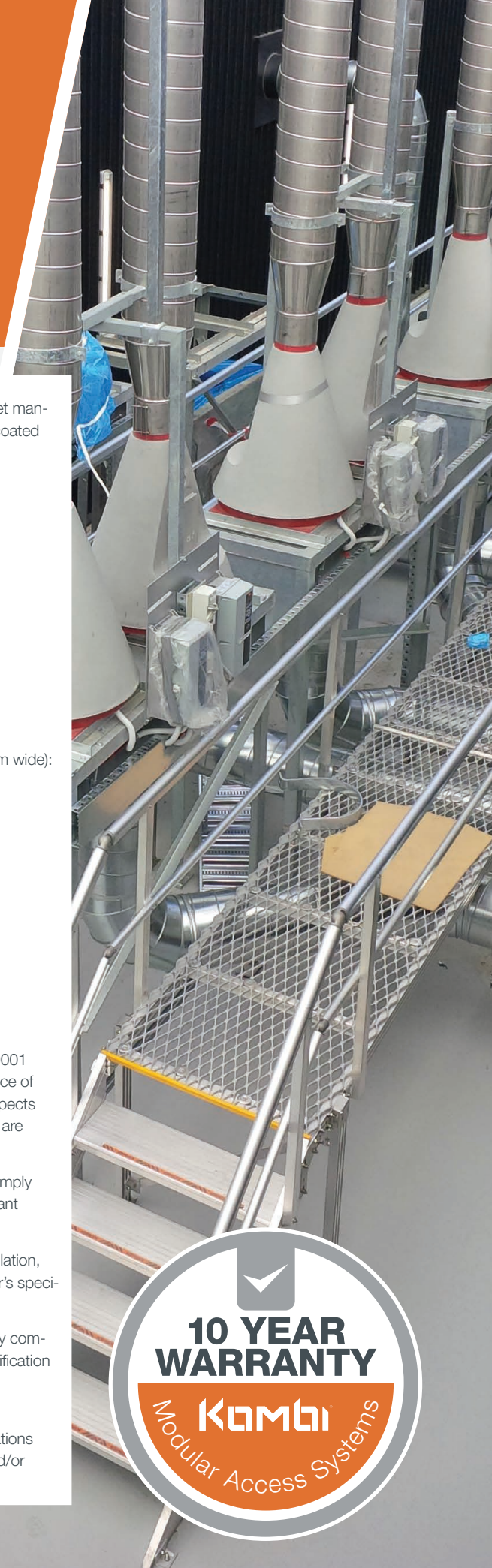



Modular Safety Systems Ltd

100-200 The Quadrant
Ash Ridge Road
Bradley Stoke
Bristol
BS32 4QA

kattsafety.co.uk | 0800 0590 400 | katt@modsafe.co.uk

Version 1 | October 2022

KATT
SAFETY

A MODULAR SAFETY SYSTEMS BRAND